

# Condor Script Form

## Folding Frame Day Wheelchair 90050



**To Order** Fill in the frame dimensions and features required. For variations describe in detail on a separate page. If you have any further questions contact us at the address at the bottom of the page.

**SEND FORM**  
If online, click here to send via e-mail

Date \_\_\_\_\_

Name \_\_\_\_\_

Address \_\_\_\_\_

\_\_\_\_\_

Phone \_\_\_\_\_

Fax / Cell \_\_\_\_\_

Email \_\_\_\_\_

Delivery details \_\_\_\_\_

\_\_\_\_\_

Therapist details \_\_\_\_\_

\_\_\_\_\_

Required by \_\_\_\_\_

**TRIAL CHAIR REF:** \_\_\_\_\_

Disability \_\_\_\_\_ Weight \_\_\_\_\_ Height \_\_\_\_\_ Shoe Size \_\_\_\_\_ T-Shirt Size \_\_\_\_\_

### MEASUREMENTS (Refer to diagram)

**Materials**  Aluminium  Titanium **90050T**

<b>A</b> Seat width _____	<b>E</b> Seat to footplate _____	<b>I</b> Camber (0°, 3°, 5°) _____
<b>B</b> Seat depth _____	<b>F</b> Seat to floor - front _____	<b>J</b> Hanger Angle (70°, 80° or 90°) _____
<b>C</b> Back height _____	<b>G</b> Seat to floor - rear _____	<b>K</b> <input type="checkbox"/> Dynamic Rocker Back <b>AD10330</b>
<b>D</b> Back angle (0° or 5°) _____	<b>H</b> Balance Point _____	<b>Axle plate</b> <input type="checkbox"/> Standard <input type="checkbox"/> Amputee

### ADDITIONAL NOTES

(you can type here)

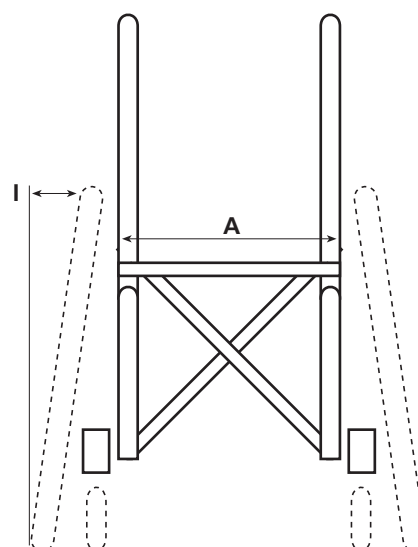
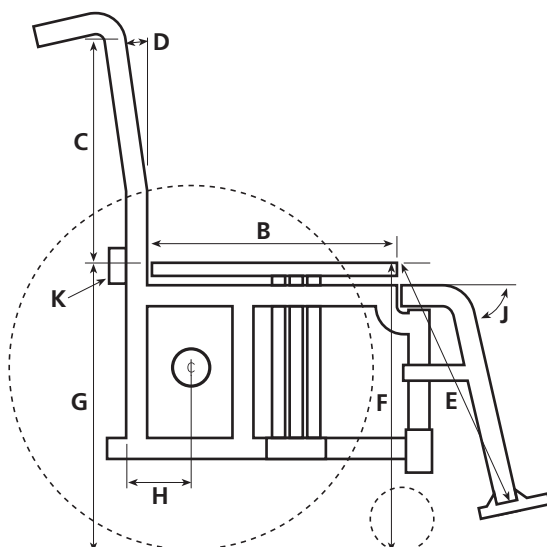

# Condor Script Form

Folding Frame Day Wheelchair

Name \_\_\_\_\_

**HANGER TYPE**

Swing Away

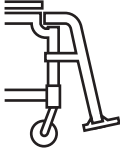

Drop In (top)



Drop In



Fixed

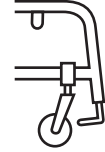

**FOOT-PLATE WIDTH**

Width for Pro T and V style foot-plates

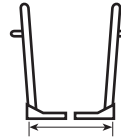
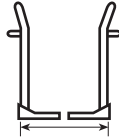

When measuring across feet you must add 2" (50mm)

**SWING AWAY FOOTREST**

Straight swing away

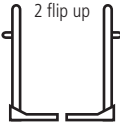

Pro T swing away

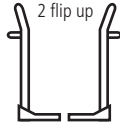

V swing away

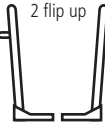

Straight swing away

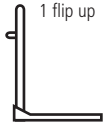

Pro T swing away



V swing away



Straight Hangers

2 piece flip up plastic foot-plate (std)

2 piece flip up, angle adjustable foot-plates **AD11521**

Pro T Hangers

1 piece flip up, angle adjustable, alloy foot-plate, opens to the left **AD11450**

V Hangers

1 piece flip up, angle adjustable, alloy foot-plate, opens to the right (pictured) **AD11450**

**DROP IN FOOTREST**

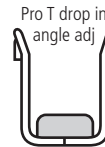
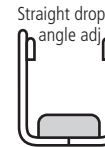
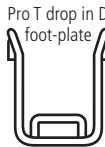
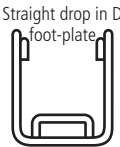
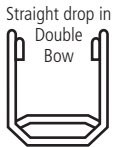

Straight Hangers

Double Bow style foot-plate (std)

Angle adjustable foot-plate **AD11520**

Pro T Hangers

D style foot-plate (std)

ABS on foot-plate **AD11500**

**FIXED FOOTREST**

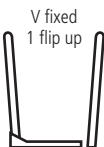
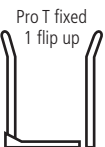
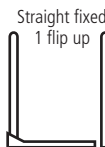
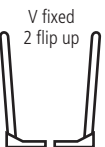
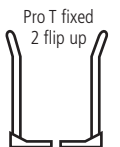
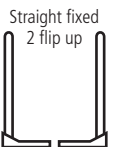

Straight Hangers

2 piece flip up plastic foot-plate (std)

2 piece flip up, angle adjustable foot-plates **AD11521**

Pro T Hangers

1 piece flip up, angle adjustable, alloy foot-plate, opens to the left **AD11450**

V Hangers

1 piece flip up, angle adjustable, alloy foot-plate, opens to the right (pictured) **AD11450**

**ELEVATING LEG REST**

Made for the Swing Away front only

Left **AD11610**

Right **AD11610**

Both **AD11600**

**STUMP SUPPORT**

Made for the Fixed and Swing Away fronts only

Left **AD11650**

Fixed

Right **AD11650**

Removable

Both **AD11651**

# Condor Script Form

## Folding Frame Day Wheelchair

Name \_\_\_\_\_

**CASTORS**

- |                                                    |                                                    |                                                    |                                                  |
|----------------------------------------------------|----------------------------------------------------|----------------------------------------------------|--------------------------------------------------|
| <input type="checkbox"/> Rollerblade (std)         | <input type="checkbox"/> 5" solid (std)            | <input type="checkbox"/> 6" solid (std)            | <input type="checkbox"/> 8" x 1" solid AD11760   |
| <input type="checkbox"/> 4" solid (std)            | <input type="checkbox"/> 5" solid alloy AD11740    | <input type="checkbox"/> 6" solid alloy AD11742    | <input type="checkbox"/> 8" floater wide AD11761 |
| <input type="checkbox"/> 4" x 1.25" alloy AD11710  | <input type="checkbox"/> 5" x 1.5" solid AD11720   | <input type="checkbox"/> 6" x 1.5" solid AD11730   | <input type="checkbox"/> 8" pneumatic AD11780    |
| <input type="checkbox"/> 4" wide soft roll AD11806 | <input type="checkbox"/> 5" x 1.5" alloy AD11740   | <input type="checkbox"/> 6" x 1.5" alloy AD11742   |                                                  |
|                                                    | <input type="checkbox"/> 5" wide soft roll AD11810 | <input type="checkbox"/> 6" wide soft roll AD11820 |                                                  |
|                                                    |                                                    | <input type="checkbox"/> 6" pneumatic AD11750      |                                                  |

**FORKS**

- Standard forks (std)       Frog Legs suspension AD11950

**PUSH HANDLES**

- Nil       In back canes (std)       Stroller D AD14200       Dual clamp adj height AD14120
- Foldable in back canes AD14160       Strollers twin removable AD14240       Stroller handle with ratchet backrest AD14300

**BRAKES**

- Nil       Pull to lock AD14510       Scissor AD14520       D's-Locks AD14600
- Push to lock (std)       Hill climbers AD14530       Ergo Scissor AD14522
- Push to lock (long handle)       Brake extensions AD14550       Ergo Scissor w/spring AD14524
- Superlock Push to Lock with Brake Extensions AD14560       Reverse handles       Scissor Lock Composite AD14570

**ANTI-TIPS**

- Nil       With plastic wheels AD15000       Stainless Steel with plastic wheels AD15025       Adjustable anti tips AD15010
- Kick tube AD15040       With roller-blades AD15030       Flared w/plastic wheels AD15020 (only for w/chairs smaller than "16 wide)       Swing under anti tips AD15060

**ARMRESTS**

- Nil       T adjustable height with desk pad armrest AD15260
- Foam tube swing away, lift out AD15200       T adjustable height with full length pad armrest AD15261
- Desk pad swing away, lift out AD15210       T adjustable height desk pad armrest with ABS skirt guard AD15280
- Full pad swing away, lift out AD15220       T adjustable height full pad armrest with ABS skirt guard AD15281

**UPHOLSTERY**

- Sling (std)       Standard back (std)       No cushion       Bag under chair AD16600
- Tension adjustable back AD16010       Cushion 1" AD16201       Bag on back of chair AD16680
- Cushion 2" AD16202       Bag on front left hanger AD16620
- Cushion 3" AD16203       Bag on front right hanger AD16620

**SKIRT GUARDS**

- Nil       Fabric skirt guards AD16100       ABS skirt guards drop in AD16110

**STRAPS / BELTS, COVERS / GUARDS**

- Leg strap (std)       Fabric foot-plate cover AD11510       Seat belt - plastic buckle AD16500
- Heel loop straps (std)       Castor pivot covers AD16410       Seat belt - childrens car buckle AD16520
- Hanger Impact guards AD16400       Seat belt - adults car buckle AD16522

**TRAY**

- Nil
- Slides over armrests AD17000
- With prong receivers AD17010

**TIE DOWN MOUNTS**

- 2 front and 2 rear AD10320

# Condor Script Form

## Folding Frame Day Wheelchair

Name \_\_\_\_\_

**WHEELS****12.5" - 22"**

- 12.5" Transit Wheels  
 16" x 1.75" Composite Wheels  
 18" x 1" Spoked Wheels  
 18" x 1.75" Composite Wheels  
 20" x 1" Spoked Wheels  
 20" x 1-3/8" Spoked Wheels  
 20" x 1.75" Spoked Wheels  
 20" x 1.75" Composite Wheels  
 20" X-Core Wheels  
 22" x 1" Spoked Wheels  
 22" x 1-3/8" Spoked Wheels  
 22" Spinergy LX Wheels (12 spoke - black only) **AD13310**  
 22" X-Core Wheels

**24"**

- Spoked Wheels (std)  
 Composite Wheels  
 Spinergy Day Wheels (18 spoke) **AD13300** (Choose your spoke colour) **Bk R Bl W Y**  
 Spinergy LX Wheels (12 spoke) **AD13310** (Choose your spoke colour) **Bk R Bl W Y Gr Pk O**  
 Spinergy LX Wheels with FlexRim (12 spoke - black only) **AD13315**  
 X Core Wheels (5 spoke) **AD13108**  
 Dino Wheels **AD13360** (Choose your spoke colour) **Bk R Bl Sv Go Gr Pk O LB Pu**  
 BMX Wheels (std)

**25"**

- Spoked Wheels (std)  
 Spinergy Day (18 spoke) **AD13300** (Choose your spoke colour) **Bk R Bl W Y**  
 Spinergy LX (12 spoke) **AD13310** (Choose your spoke colour) **Bk R Bl W Y Gr Pk O**  
 Spinergy LX Wheels with FlexRim (12 spoke - black only) **AD13315**  
 X Core Wheels (3 spoke) **AD13200**  
 Dino Wheels **AD13360** (Choose your spoke colour) **Bk R Bl Sv Go Gr Pk O LB Pu**  
 BMX Wheels (std)

**26"**

- Spoked Wheels (std)  
 Spinergy Day (18 spoke) **AD13300** (Choose your spoke colour) **Bk R Bl W Y**  
 Spinergy LX (12 spoke) **AD13310** (Choose your spoke colour) **Bk R Bl W Y Gr Pk O**  
 BMX Wheels (std)

 Spare Wheel(s) Type: \_\_\_\_\_

Tyres: \_\_\_\_\_ Pushrims: \_\_\_\_\_ Size: \_\_\_\_\_

**TYRES****12.5" - 22"**

- 12.5" Tread (std)  
 16" x 1.75" Tread (std)  
 18" x 1" HP Smooth (std)  
 18" x 1.75" Tread (std)  
 20" x 1" HP Smooth (std)  
 20" x 1-3/8" Tread (std)  
 20" x 1-3/8" Solid Tread (std)  
 20" x 1.75" Tread (std)  
 22" x 1" HP Smooth (std)  
 22" x 1-3/8" Tread (std)  
 22" x 1-3/8" Solid Tread (std)

**24"**

- 24" x 1" HP Smooth (std)  
 24" x 1" HP Tread (std)  
 24" x 1" Solid (std)  
 24" x 1-3/8" Tread (std)  
 24" x 1-3/8" Solid (std)  
 24" x 1-3/8" Kenda HP Tread **AD13710**  
 24" x 1-3/8" Primo V-Trak Knobbly **AD13715**  
 24" x 1" Kenda Ironcap Blue **AD13700**  
 24" x 1" Kenda Konstrictor **AD13720**  
 24" x 1" Schwalbe Right Run **AD13740**  
 24" x 1" Schwalbe Marathon Evo **AD13750**  
 BMX Tread (std)

**25"**

- 25" x 1" HP Smooth (std)  
 25" x 1" Solid (std)  
 25" x 1" Kenda Ironcap Blue **AD13700**  
 25" x 1" Kenda Konstrictor **AD13720**  
 25" x 1" Schwalbe Right Run **AD13740**  
 25" x 1" Schwalbe Marathon Evo **AD13750**  
 BMX Tread (std)

**26"**

- 26" x 1" HP Smooth (std)  
 26" x 1-3/8" Tread (std)  
 26" x 1" Solid (std)  
 26" x 1" Schwalbe Right Run **AD13740**  
 26" x 1" Schwalbe Marathon Evo **AD13750**  
 BMX Tread (std)

**PUSHRIMS**

- |                                                       |                                                               |                                                            |                                                          |
|-------------------------------------------------------|---------------------------------------------------------------|------------------------------------------------------------|----------------------------------------------------------|
| <input type="checkbox"/> Anodised (std)               | <input type="checkbox"/> Rubber coated (black) <b>AD13850</b> | <input type="checkbox"/> Foam <b>AD13840</b>               | <input type="checkbox"/> Natural Fit Lite <b>AD13860</b> |
| <input type="checkbox"/> Anodised (1") <b>AD13855</b> | <input type="checkbox"/> Rubber coated (1") <b>AD13857</b>    | <input type="checkbox"/> Spinergy FlexRim - see Wheels     | <input type="checkbox"/> Max Greppe <b>AD13870</b>       |
| <input type="checkbox"/> Vinyl <b>AD13830</b>         | <input type="checkbox"/> Surge <b>AD13864</b>                 |                                                            |                                                          |
| <input type="checkbox"/> Vinyl (1") <b>AD13859</b>    | <input type="checkbox"/> Surge Lite <b>AD13864</b>            | <input type="checkbox"/> Capstan No. of projections: _____ | Angle: _____ Length: _____                               |

**PUSHRIMS - POSITION**

- Standard  
 In close  
 Onto rim

**AXLES**

- Quick release axles (std)  
 Quad release **AD12500**

**SPOKE GUARDS**

- Clear polycarb **AD13900**  
 Black ABS **AD13901**

# Condor Script Form

## Folding Frame Day Wheelchair

Name \_\_\_\_\_

**COLOURS**

- 27 Candy Blue
- 1 Royal Blue
- 72 Glass Blue
- 16 Candy Purple
- 48 Burgundy
- 83 Candy Raspberry
- 88 Fluro Pink
- 28 Candy Red
- 11 Flame
- 57 Super Hot Chilli
- 80 Candy Orange
- 71 Pure Orange
- 68 Crystal Yellow
- 73 Crystal Jade
- 89 Fluro Green
- 70 Candy Emerald
- 2 Hawthorn Green
- 17 Crystal Sapphire

**ATTENTION**

**THIS IS A GUIDE TO COLOURS ONLY, how colours appear on your monitor or when printed out may vary.**

Contact us if you require assistance or a colour sample.

This colour selection is for our aluminum frames only.

We do not recommend powder coating titanium.

Colour availability is subject to change without notice, contact us if you are concerned about the availability of your colour.

- 55 Silver Sparkle
- 12 Silver Orbiter
- 46 Chrome
- 42 Metallic Viper
- 30 Satin Black
- 61 High Gloss Black
- 62 Matt Black
- 63 Texture Matt Black
- 18 Clear
- Bead Blast** (titanium only)
- Custom Colour** (additional cost)
- Description

