

Piranha Script Form

Fixed Frame Day Wheelchair 90400



To Order Fill in the frame dimensions and features required. For variations describe in detail on a separate page. If you have any further questions contact us at the address at the bottom of the page.

SEND FORM
If online, click here to send via e-mail

Date _____

Name _____

Address _____

Phone _____

Fax / Cell _____

Email _____

Disability _____

Weight _____

Height _____

Delivery details _____

Therapist details _____

Required by _____

TRIAL CHAIR REF: _____

Shoe Size _____

T-Shirt Size _____

MEASUREMENTS (Refer to diagram below)

Frame Materials

Aluminium (std) Titanium **90400T**

A Seat Width _____

B Seat Length _____

C Back Height _____

D Back Angle° _____

E Seat to Footplate _____

F Frame Length _____

G Seat to Floor - Front _____

H Seat to Floor - Rear _____

I Balance Point _____

J Castor Pivot Position _____

K Castor Pivot Centres _____

L Footplate Width _____

M Camber (0° - 5°) _____

Ergo Seat Option **AD10220**

N Ergo Seat Length _____

O Ergo Back Height _____

P Ergo Back Angle° _____

Front Hanger Taper Style

V Front Pro T Front

Camber Bar Position

Adjustable Fixed

ADDITIONAL NOTES

(you can type here)

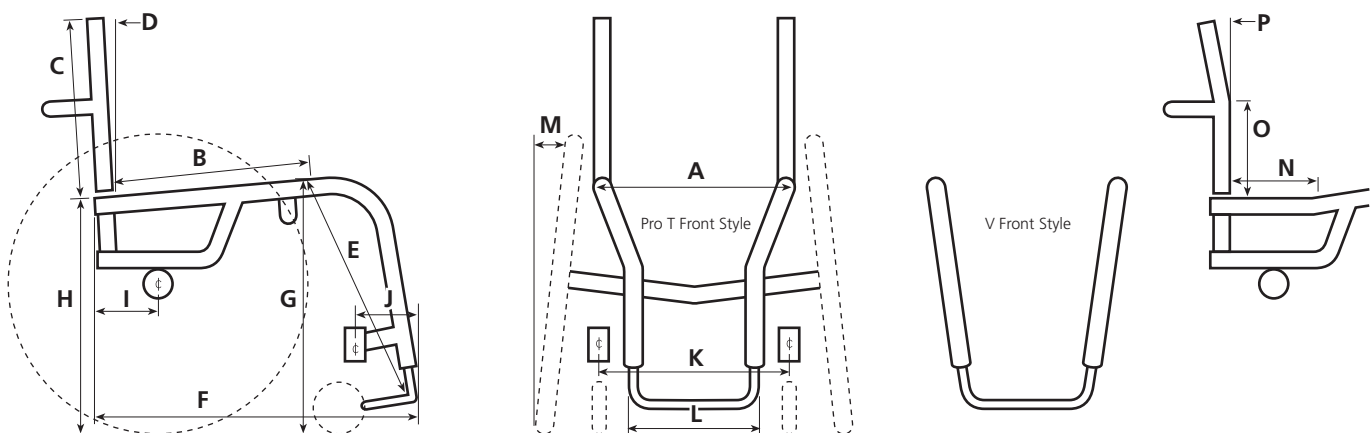

Piranha Script Form

Fixed Frame Day Wheelchair

Name _____

BACK REST

- Folding back (std) Fixed back

FOOTPLATE

- Standard Angle adjustable AD11520 ABS on footplate AD11500 Fabric padded cover AD11510

CASTORS

- Rollerblade (std) 5" solid (std) 6" solid (std) 8" solid AD11760
 4" solid (std) 5" solid alloy AD11740 6" solid alloy AD11742 8" pneumatic AD11780
 4" x 1.25" alloy AD11710 5" x 1.5" solid AD11720 6" x 1.5" solid AD11730
 4" wide soft roll AD11806 5" x 1.5" alloy AD11740 6" x 1.5" alloy AD11742
 5" wide soft roll AD11810 6" wide soft roll AD11820
 6" pneumatic AD11750

FORKS

- Standard forks (std) Ultralight bearing forks AD11910 Frog Legs suspension AD11950 Frog Legs Unitine AD11920

PUSH HANDLES

- Nil Removable AD14100 Height adj dual clamp AD14120 Foldable in back canes AD14160

BRAKES

- Nil Superlock Push to Lock with Brake Extensions AD14560 Scissor (std) Scissor Lock Composite AD14570
 Push to lock (std) Brake extension left AD14550 Ergo Scissor AD14522 D's-Locks AD14600
 Pull to lock AD14510 Brake extension right AD14550 Ergo Scissor w/spring AD14524 Hill climbers AD14530

ANTI-TIPS

- Nil Single centre mount anti-tip with plastic wheels AD15070
 Pair of single anti-tips with plastic wheels AD15000 Single centre mount anti-tip with rollerblades AD15080
 Pair of single anti-tips with rollerblades AD15030 Dual tube one piece swivel anti-tip with rollerblade AD15150

ARMRESTS

- Nil T adjustable height with desk pad armrest AD15260
 ABS skirt guard attached to full length pad armrest AD15281 T adjustable height with full length pad armrest AD15261

UPHOLSTERY

- Sling (std) Standard back (std) No cushion Bag under chair AD16600
 Tension adjustable back AD16010 Cushion 1" AD16201 Bag on back of chair AD16680
 Cushion 2" AD16202 Bag on right front hanger AD16620
 Cushion 3" AD16203 Bag on front left hanger AD16620
 Wheel bag AD16780

SKIRT GUARDS

- Nil ABS drop in AD16110 Alloy fixed AD16130 Carbon Fibre fixed AD16161
 Fabric skirt guards AD16100 ABS fabric covered AD16120 Alloy folding AD16140 Carbon Fibre folding AD16160

STRAPS, IMPACT GUARDS

- Leg strap (std) Impact guards front hangers AD16400 Impact guards grab bar AD16420 Impact guards bottom bar AD16422
- Impact guards made only if suitable after fitting anti tips, push handles etc.

Piranha Script Form

Fixed Frame Day Wheelchair

Name _____

WHEELS**24"**

- Spoked Wheels (std)
- Spinergy Day Wheels (18 spoke) **AD13300** (Choose your spoke colour) **Bk R Bl W Y**
- Spinergy LX Wheels (12 spoke) **AD13310** (Choose your spoke colour) **Bk R Bl W Y Gr Pk O**
- Spinergy LX Wheels with FlexRim (12 spoke - black only) **AD13315**
- X Core Wheels (5 spoke) **AD13108**
- Spider Wheels **AD13100**
- Topolino Wheels **AD13350**
- Dino Wheels **AD13360** (Choose your spoke colour) **Bk R Bl Sv Go Gr Pk O LB Pu**
- Glance Wheels **AD13400** (Wheel Type)
- BMX Wheels (std)

25"

- Spoked Wheels (std)
- Spinergy Day (18 spoke) **AD13300** (Choose your spoke colour) **Bk R Bl W Y**
- Spinergy LX (12 spoke) **AD13310** (Choose your spoke colour) **Bk R Bl W Y Gr Pk O**
- Spinergy LX Wheels with FlexRim (12 spoke - black only) **AD13315**
- X Core Wheels (3 spoke) **AD13200**
- Topolino Wheels **AD13350**
- Dino Wheels **AD13360** (Choose your spoke colour) **Bk R Bl Sv Go Gr Pk O LB Pu**
- Glance Wheels **AD13400** (Wheel Type)
- BMX Wheels (std)

26"

- Spoked Wheels (std)
- Spinergy Day (18 spoke) **AD13300** (Choose your spoke colour) **Bk R Bl W Y**
- Spinergy LX (12 spoke) **AD13310**
- BMX Wheels (std)

 Spare Wheel(s) Type: _____

Tyres: _____

Pushrims: _____

Size: _____

TYRES**24"**

- 24" x 1" HP Smooth (std)
- 24" x 1" HP Tread (std)
- 24" x 1" Solid (std)
- 24" x 1-3/8" Tread (std)
- 24" x 1-3/8" Solid (std)
- 24" x 1-3/8" Kenda HP Tread **AD13710**
- 24" x 1-3/8" Knobbly V-Trak **AD13715**
- 24" x 1" Kenda Ironcap Blue **AD13700**
- 24" x 1" Kenda Konstrictor **AD13720**
- 24" x 1" Schwalbe Right Run **AD13740**
- 24" x 1" Schwalbe Marathon Evo **AD13750**
- BMX Tread (std)

25"

- 25" x 1" HP Smooth (std)
- 25" x 1" Solid (std)
- 25" x 1" Kenda Ironcap Blue **AD13700**
- 25" x 1" Kenda Konstrictor **AD13720**
- 25" x 1" Schwalbe Right Run **AD13740**
- 25" x 1" Schwalbe Marathon Evo **AD13750**
- BMX Tread (std)

26"

- 26" x 1" HP Smooth (std)
- 26" x 1-3/8" Tread (std)
- 26" x 1" Solid (std)
- 26" x 1" Schwalbe Right Run **AD13740**
- 26" x 1" Schwalbe Marathon Evo **AD13750**
- BMX Tread (std)

AXLES

- Quick release axles (std) Quad release **AD12500**

PUSHRIMS

- Anodised (std) Anodised (1") **AD13855** Foam **AD13840** Natural Fit Lite **AD13860**
- Vinyl **AD13830** Vinyl (1") **AD13859** Surge **AD13864** Max Greppe **AD13870**
- Rubber coated (black) **AD13850** Rubber coated (1") **AD13857** Surge Lite **AD13864** Spinergy FlexRim - see Wheels

PUSHRIMS - POSITION

- Standard In close Onto rim

SPOKE GUARDS



















- Nil Clear polycarb **AD13900** Black ABS **AD13901**

Piranha Script Form

Fixed Frame Day Wheelchair

Name _____

COLOURS

- 27 Candy Blue 
- 1 Royal Blue 
- 72 Glass Blue 
- 16 Candy Purple 
- 48 Burgundy 
- 83 Candy Raspberry 
- 88 Fluro Pink 
- 28 Candy Red 
- 11 Flame 
- 57 Super Hot Chilli 
- 80 Candy Orange 
- 71 Pure Orange 
- 68 Crystal Yellow 
- 73 Crystal Jade 
- 89 Fluro Green 
- 70 Candy Emerald 
- 2 Hawthorn Green 
- 17 Crystal Sapphire 

ATTENTION











THIS IS A GUIDE TO COLOURS ONLY, how colours appear on your monitor or when printed out may vary.

Contact us if you require assistance or a colour sample.

This colour selection is for our aluminum frames only.

We do not recommend powder coating titanium.

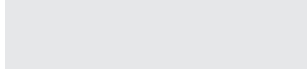
Colour availability is subject to change without notice, contact us if you are concerned about the availability of your colour.

- 55 Silver Sparkle 
- 12 Silver Orbiter 
- 46 Chrome 
- 42 Metallic Viper 
- 30 Satin Black 
- 61 High Gloss Black 
- 62 Matt Black 
- 63 Texture Matt Black 
- 18 Clear 
- Bead Blast** (titanium only) 
- Custom Colour** (additional cost)
Description _____