

Stallion Junior Script

Childrens Fixed Frame Day Wheelchair 90150



To Order Fill in the frame dimensions and features required. For variations describe in detail on a separate page. If you have any further questions contact us at the address at the bottom of the page.

SEND FORM
If online, click here to send via e-mail

Date _____	Delivery details _____			
Name _____	_____			
Address _____	_____			
_____	Therapist details _____			
Phone _____	_____			
Fax / Cell _____	Required by _____			
Email _____	TRIAL CHAIR REF: _____			
Disability _____	Weight _____	Height _____	Shoe Size _____	T-Shirt Size _____

MEASUREMENTS (Refer to diagram below)

Growable Sizes Sizes up to 14" wide are growable up to 16" wide maximum

A Seat width _____	D Back angle (0° to 10°) _____	G Seat to floor - rear _____	J Camber (0° or 3°) _____
B Seat depth _____	E Seat to footplate _____	H Balance Point _____	K Front Style
C Back height _____	F Seat to floor - front _____	I Footplate width _____	<input type="checkbox"/> Standard <input type="checkbox"/> Flared Front

IMPORTANT Ensure measurements C, E, F, G provide allowance for the cushion thickness

ADDITIONAL NOTES
(you can type here)

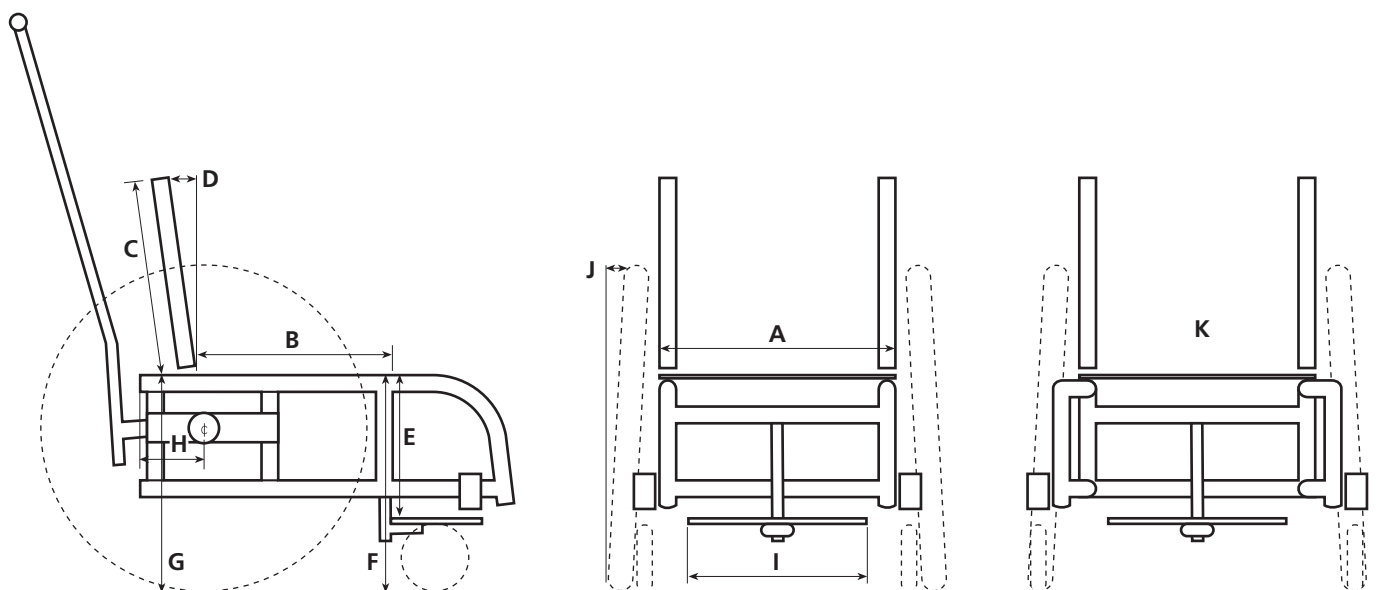

Stallion Junior Script

Childrens Fixed Frame Day Wheelchair

Name _____

BACK REST

- Folding back (std) Fixed back

FOOTPLATE

- Fixed One piece flip back ABS on fixed footplate **AD11500**
 Fixed angle adjustable **AD11520** Fabric padded cover for fixed or angle adjustable footplate **AD11510**

CASTORS

- Rollerblade (std) 4" solid (std) 5" solid (std) 5" x 1.5" alloy **AD11740**
 4" x 1.25" alloy **AD11710** 5" solid alloy **AD11740** 5" wide soft roll **AD11810**
 4" wide soft roll **AD11806** 5" x 1.5" solid **AD11720**

FORKS

- Standard adjustable forks (std)

PUSH HANDLES

- Nil In back canes **AD14140** Dual clamp adj height **AD14120** Removable single **AD14150**
 Height from floor to top of handle _____ Removable double **AD14260**

BRAKES

- Nil Push to lock (std) Ergo Scissor **AD14522** Brake extension left **AD14550**
 Pull to lock **AD14510** Ergo Scissor w/spring **AD14524** Brake extension right **AD14550**
 Superlock Push to Lock with Brake Extensions **AD14560** Scissor Lock Composite **AD14570** Hill climbers **AD14530**

ANTI-TIPS

- Nil Pair of flared anti-tips with plastic wheels **AD15020**
 Pair of anti-tips with rollerblades **AD15030** Pair of adjustable anti-tips with plastic wheels **AD15010**
 Pair of anti-tips with plastic wheels **AD15000** Pair of swing under anti-tips with plastic wheels **AD15060**

ARMRESTS

- Nil T height adj child's (8") pad armrest with ABS skirt guard **AD15279**
 T height adjustable with child's (8") pad armrest **AD15259** T height adj desk (10") pad armrest with ABS skirt guard **AD15280**
 T height adjustable with desk (10") pad armrest **AD15260** T height adj full length (14") pad armrest with ABS skirt guard **AD15281**
 T height adjustable with full length (14") pad armrest **AD15261**

UPHOLSTERY

- Sling (std) No Cushion Cushion 2" **AD16202** Bag under chair **AD16600**
 Tension adjustable back (std) Cushion 1" **AD16201** Cushion 3" **AD16203** Bag on back of chair **AD16680**

SKIRT GUARDS

- Nil Fabric skirt guards **AD16100** ABS drop in **AD16110** Mud guards **AD16164**
 ABS fabric covered **AD16120**

STRAPS / BELTS, IMPACT GUARDS

- Leg strap (std) Seat belt, plastic buckle **AD16500** Hip strap 4 point belt **AD16540**
 Impact guards front hangers **AD16400** Seat belt (child's) with metal car type buckle **AD16520**

TRAY

- Tray slides over armrests **AD17000** Tray with prong receivers **AD17010**

Stallion Junior Script

Childrens Fixed Frame Day Wheelchair

Name _____

WHEELS**TYRES****12.5"** 12.5" Transit Wheels**12.5"** 12.5" Tread (std) 12.5" Solid Tread (std)**16"** 16" x 1.75" Composite Wheels**16"** 16" x 1.75" Tread (std) 16" x 1.75" Solid Tread (std)**18"** 18" x 1" Spoked Wheels 18" x 1.75" Composite Wheels**18"** 18" x 1" HP Smooth (std) 18" x 1.75" Grey Tread (std)**20"** 20" Spoked Wheels 20" x 1.75" Spoked Wheels 20" x 1 3/8" Composite Wheels 20" X-Core Composite Wheels**20"** 20" x 1" HP Smooth (std) 20" x 1 3/8" Tread (std) 20" x 1 3/8" Solid Tread (std) 20" x 1.75" Grey Tread (std)**22"** 22" Spoked Wheels 22" X-Core Composite Wheels 22" Spinergy LX Wheels (12 spoke - black only) **AD13310****22"** 22" x 1" HP Smooth (std) 22" x 1 3/8" Tread (std) 22" x 1 3/8" Solid Tread (std) Spare Wheel(s) Type: _____

Tyres: _____

Pushrims: _____

Size: _____

AXLES Quick release axles (std) Quad release **AD12500****PUSHRIMS** Anodised (std) Rubber Coated (black) **AD13850** Capstan **AD13880**

No. projections: _____

Angle: _____

Length: _____

PUSHRIMS - POSITION Standard In close Onto rim**SPOKE GUARDS** Nil Clear polycarb **AD13900** Black ABS **AD13901** Custom design **AD13910**
Describe design below**ADDITIONAL NOTES**

















(you can type here)

Stallion Junior Script

Childrens Fixed Frame Day Wheelchair

Name _____

COLOURS

- 27 Candy Blue 
- 1 Royal Blue 
- 72 Glass Blue 
- 16 Candy Purple 
- 48 Burgundy 
- 83 Candy Raspberry 
- 88 Fluro Pink 
- 28 Candy Red 
- 11 Flame 
- 57 Super Hot Chilli 
- 80 Candy Orange 
- 71 Pure Orange 
- 68 Crystal Yellow 
- 73 Crystal Jade 
- 89 Fluro Green 
- 70 Candy Emerald 
- 2 Hawthorn Green 
- 17 Crystal Sapphire 

ATTENTION











THIS IS A GUIDE TO COLOURS ONLY, how colours appear on your monitor or when printed out may vary.

Contact us if you require assistance or a colour sample.

This colour selection is for our aluminum frames only.

We do not recommend powder coating titanium.

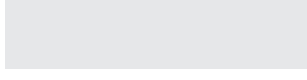
Colour availability is subject to change without notice, contact us if you are concerned about the availability of your colour.

- 55 Silver Sparkle 
- 12 Silver Orbiter 
- 46 Chrome 
- 42 Metallic Viper 
- 30 Satin Black 
- 61 High Gloss Black 
- 62 Matt Black 
- 63 Texture Matt Black 
- 18 Clear 
- Bead Blast** (titanium only) 
- Custom Colour** (additional cost)
Description _____