

Wolverine Script Form

Lacrosse Sports Wheelchair

90828



To Order Fill in the frame dimensions and features required. For variations describe in detail on a separate page. If you have any further questions contact us at the address at the bottom of the page.

SEND FORM
If online, click here to send via e-mail

Date _____

Name _____

Address _____

Phone _____

Fax / Cell _____

Email _____

Delivery details _____

Required by _____
(Delivery is normally 4-6 weeks from order confirmation)

Disability _____ Grading _____ Weight _____ Height _____ Shoe Size _____ T-Shirt Size _____

MEASUREMENTS (Refer to diagrams)

Frame Materials Aluminium (std) Titanium **90828T**

Seat Width - Rear _____ **F** Back Angle° _____

Seat Width - Front _____ **G** Seat to Foot-plate _____

A Back Width _____ **H** Frame Length _____
(centre of camber bar to front of wing bar)

B Seat Length _____ **I** Wheel Base _____
(centre of camber bar to centre of pivot)

C Back Splay - Top _____ **J** Seat to Floor - Front _____

D Back Splay - Length _____ **K** Seat to Floor - Rear _____

E Back Height _____ **L** Balance Point _____

M Pivot Centres _____

N Foot-plate Position _____

O Between Wheels _____

P Camber _____

Q Foot-plate Width _____

R BINDING MOUNTS
 Standard Custom

S Flexible Backpost Cap AD20310
(fixed back height only)

WING BAR
T **U** **V**

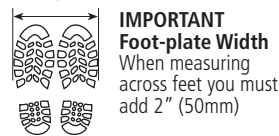

ERGO SEAT AD10220
W Ergo Seat - Length _____

X Ergo Back - Height _____

Y Ergo Back - Angle _____

ADDITIONAL NOTES
(you can type here)

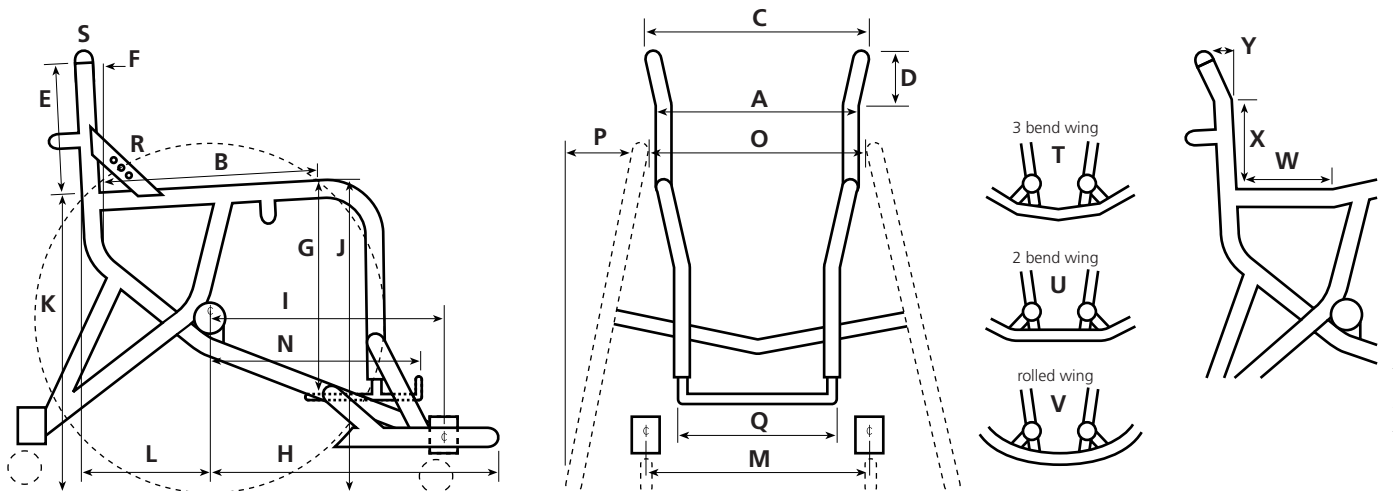

Wolverine Script Form

Lacrosse Sports Wheelchair

Name _____

FOOTPLATE

- No Footplate Alloy tube footplate (std) Alloy footplate cover **AD11690**

ANTI-TIPS

- Twin swivel **AD15150** Single swivel **AD15100**

BEARINGS

- Standard bearings Melrose hybrid ceramic bearings **AD20400**

CASTORS

- Rollerblade 72mm (std) Other _____

UPHOLSTERY

- Seat sling fixed (std) Fixed width back (std) No cushion Cushion 3" **AD16203**
 Seat sling wrap-around Adjustable back upholstery with Cushion 1" **AD16201** Cushion 1" (high density) **AD16221**
 Solid seat **AD18030** adjustable width/height **AD16050** Cushion 2" **AD16202** Cushion 2" (high density) **AD16220**

SKIRT GUARDS

- No skirt guards Fabric skirt guards **AD16100** Alloy skirt guards **AD16125** (height) _____
 ABS rigid skirt guards **AD16111** (height) _____

STRAPS, IMPACT GUARDS

- Front hanger covers **AD16400** Hip strap - webbing **AD16510** Leg strap **AD16330**
 Back bar cover **AD16420** Hip strap - ratchet **AD16550** Chest strap **AD45210**
 Foot strap - webbing (std) (measure around your chest and seat back)

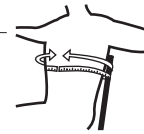
**ACCESSORIES**

- Wheel bag (black with choice of trim colour) **AD16780** (Choose your trim colour) **Blk R Bl Y Gr Pk Pu** Custom Wheel Bag **AD16781** (describe below)

ADDITIONAL NOTES

(you can type here)

Wolverine Script Form

Lacrosse Sports Wheelchair

Name _____

WHEELS**24"**

- Spoked Wheels (std)
- Spinergy SL Wheels (24 spoke, black spokes only) **AD13410**
- Spinergy SLX Wheels (24 spoke, black spokes only) **AD13420**

25"

- Spoked Wheels **AD13060**
- Spinergy SL Wheels (24 spoke, black spokes only) **AD13410**
- Spinergy SLX Wheels (24 spoke, black spokes only) **AD13420**

26"

- Spoked Wheels **AD13060**
- Spinergy SL Wheels (24 spoke, black spokes only) **AD13410**
- Spinergy SLX Wheels (24 spoke, black spokes only) **AD13420**

27"

- Spoked Wheels **AD13060**
- Spinergy SL Wheels (24 spoke, black spokes only) **AD13410**
- Spinergy SLX Wheels (24 spoke, black spokes only) **AD13420**

TYRES**24"**

- 24" x 1" Kenda Ironcap Blue (std)
- 24" x 1" Kenda Konstrictor (std)
- 24" x 1" Schwalbe Right Run **AD13740**

25"

- 25" x 1" Kenda Ironcap Blue (std)
- 25" x 1" Kenda Konstrictor (std)
- 25" x 1" Schwalbe Right Run **AD13740**

26"

- 26" x 1" Kenda Ironcap Blue (std)
- 26" x 1" Schwalbe Right Run **AD13740**

27"

- 27" x 1" Kenda Ironcap Blue (std)

PUSHRIMS

- Anodised alloy (std) Rubber coated (red) **AD13845**

PUSHRIMS - POSITION

- Standard In close Onto rim

SPOKE GUARDS

- Nil Pair of Spoke guards **AD13920**

SPARE WHEELS as above

- Spoked Wheel 24" **AD13507** (quantity) _____
- Spoked Wheel 25"/26"/27" **AD13561** (quantity) _____
- Spinergy SL Wheel **AD13641** (quantity) _____
- Spinergy SLX Wheel 1/2" axle **AD13651** (quantity) _____

SPOKE GUARDS for SPARE WHEELS as above

- Fitted to spare wheel Not fitted to spare wheel
- Spoke Guard **AD13921** (quantity) _____

EXTRA AXLES

- Axles 1/2" **AD12514** (quantity) _____

TYRES, TUBES and AXLES on SPARE WHEELS

- Tube fitted **AD13695** (quantity) _____
- Kenda Tyre fitted **AD13701** (quantity) _____
- Schwalbe Tyre fitted **AD13741** (quantity) _____
- Axle 1/2" **AD12508** (quantity) _____

PUSHRIMS for SPARE WHEELS as above

- Anodised alloy **AD13858** (quantity) _____
- Rubber coated (red) **AD13846** (quantity) _____

EXTRA BEARINGS



















- Steel 608 5/16" **AD20402** (quantity) _____
- Steel R8 1/2" **AD20405** (quantity) _____
- Ceramic 608 5/16" **AD20403** (quantity) _____
- Ceramic R8 1/2" **AD20407** (quantity) _____

Wolverine Script Form

Lacrosse Sports Wheelchair

Name _____











COLOURS

- 27 Candy Blue 
- 1 Royal Blue 
- 72 Glass Blue 
- 16 Candy Purple 
- 48 Burgundy 
- 83 Candy Raspberry 
- 88 Fluro Pink 
- 28 Candy Red 
- 11 Flame 
- 57 Super Hot Chilli 
- 80 Candy Orange 
- 71 Pure Orange 
- 68 Crystal Yellow 
- 73 Crystal Jade 
- 89 Fluro Green 
- 70 Candy Emerald 
- 2 Hawthorn Green 
- 17 Crystal Sapphire 

ATTENTION

THIS IS A GUIDE TO COLOURS ONLY, how colours appear on your monitor or when printed out may vary.

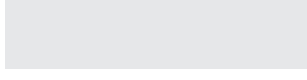
Contact us if you require assistance or a colour sample.
 This colour selection is for our aluminum frames only.
 We do not recommend powder coating titanium.
 Colour availability is subject to change without notice, contact us if you are concerned about the availability of your colour.

- 55 Silver Sparkle 
- 12 Silver Orbiter 
- 46 Chrome 
- 42 Metallic Viper 
- 30 Satin Black 
- 61 High Gloss Black 
- 62 Matt Black 
- 63 Texture Matt Black 
- 18 Clear 
- Bead Blast** (titanium only) 
- Custom Colour** (additional cost)
 Description _____